

16F84/S0

7.51 -11.58

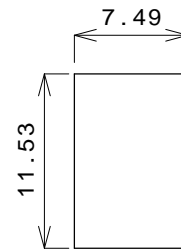

16F628/S0

7.49 -11.53

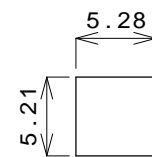

12C509A/SM

5.28 -5.21

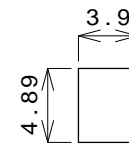

12C509A/SN

3.9 -4.89

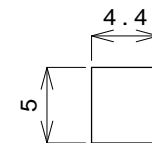

16F630 (TSSOP)

4.4 - 5.0

P=0.65typ

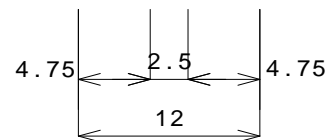

エポキシ基盤

2.6'

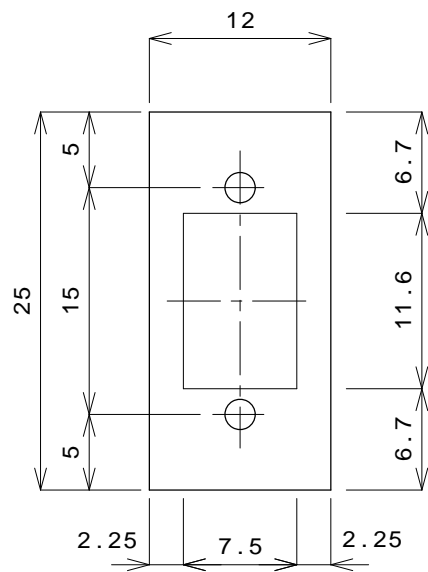

16F84/S0

16F628/S0

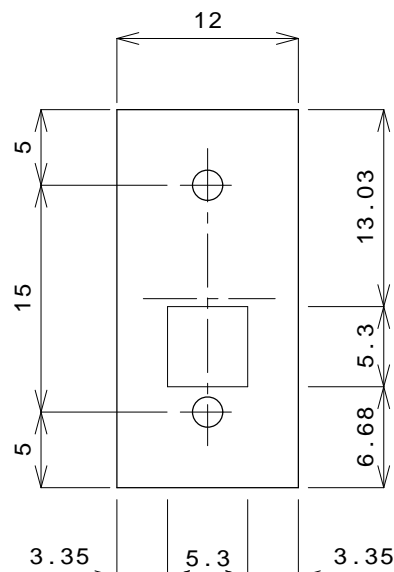

12C509A/SM

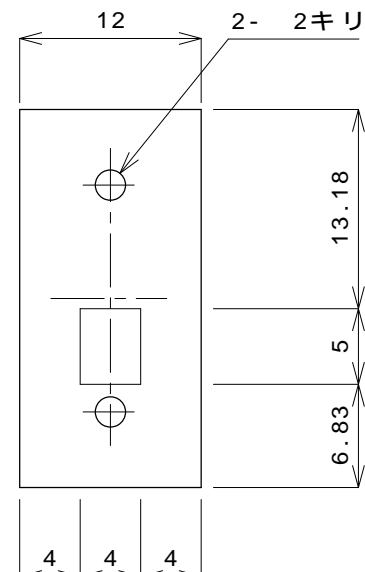

12C509A/SN

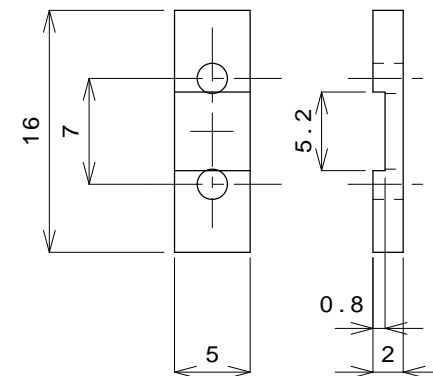

16F630 (TSSOP)

押さえ板：透明アクリル板 2.0'

PIC変換アダプター

日付 2005/05/05

湘南模型飛行機研究所

S=2/1

石川

